

# Technische Daten Mona 34-A

Wandaußenmaß: 300 x 240 cm  
Bohlenstärke: 34 mm



Kontrolliert durch:

Achtung: Alle angegebenen Maße sind ca.-Maße!

# 3D-Ansicht und Grundriss Mona 34-A

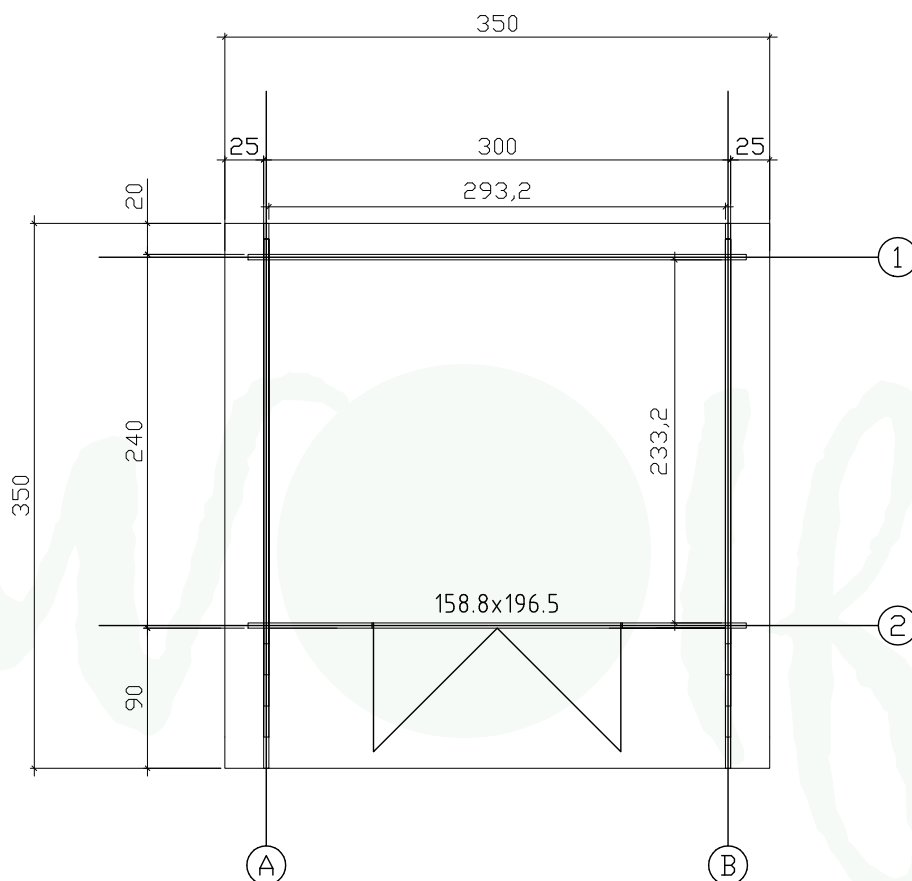
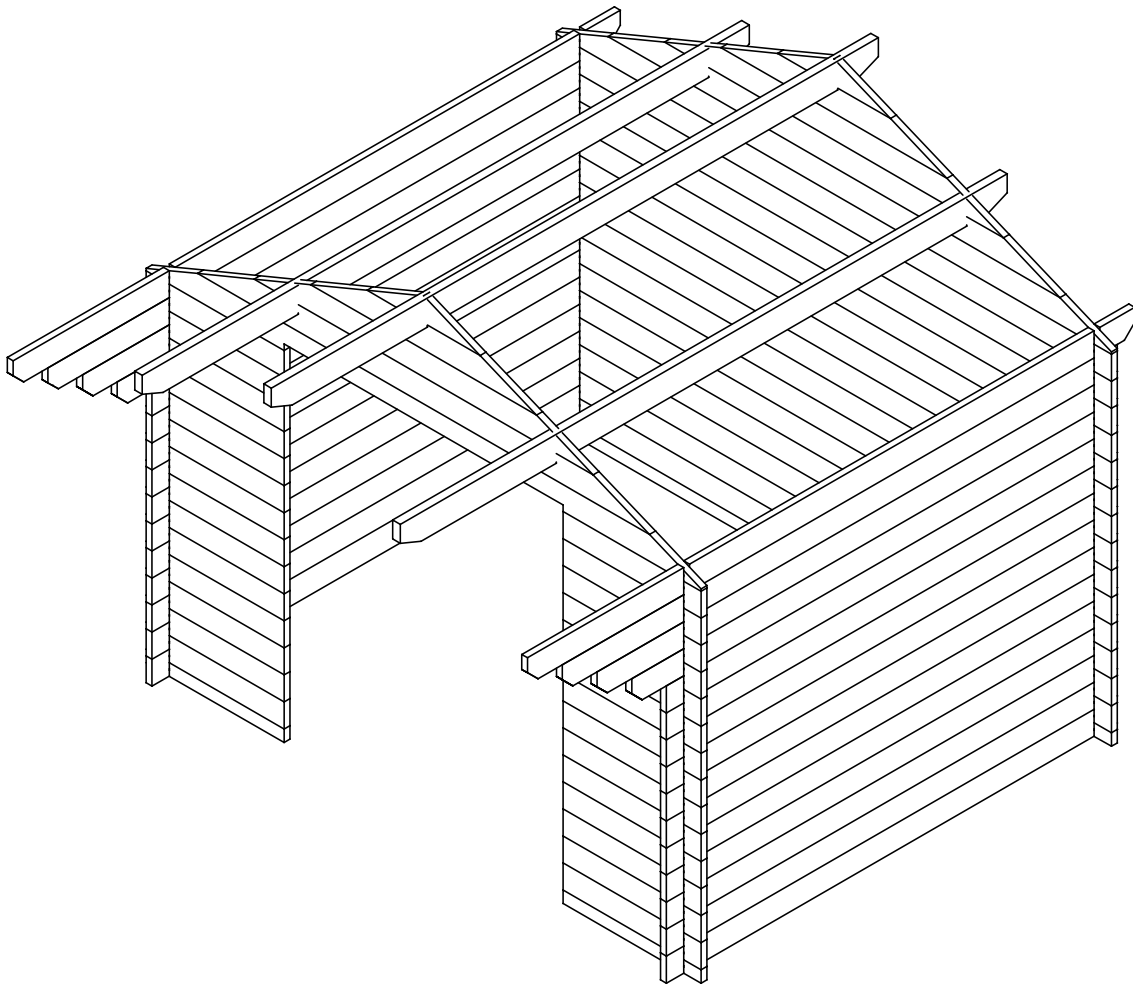

# Lagerholzplan Mona 34-A

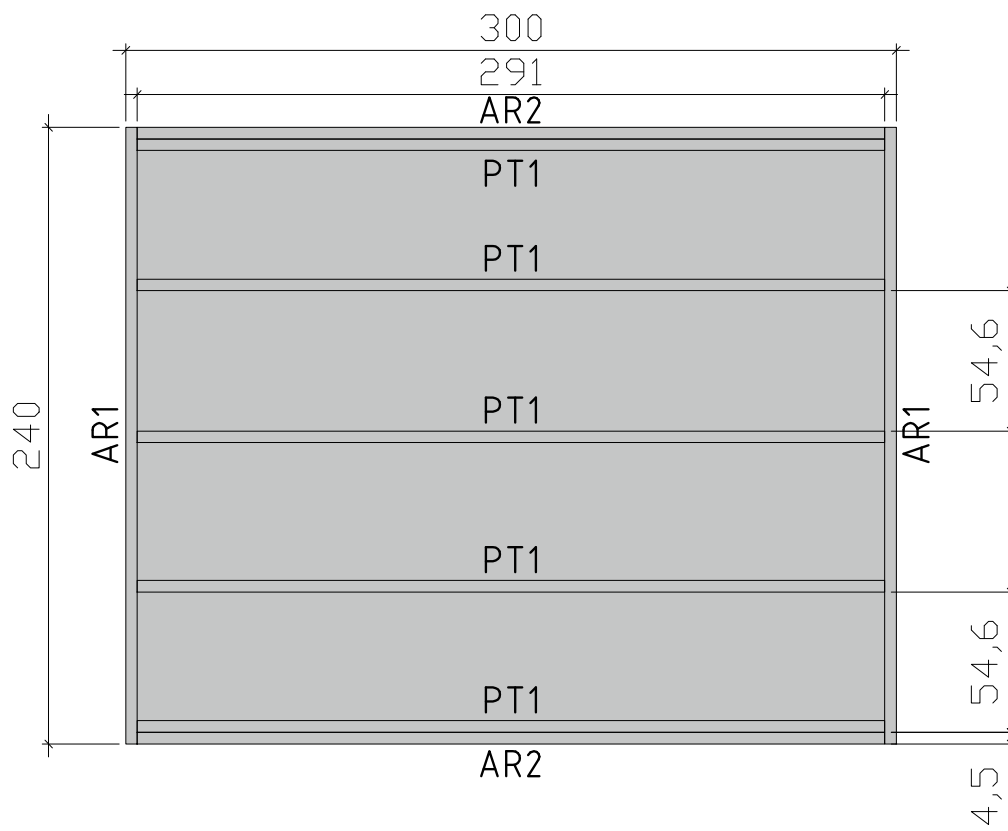

# Fundamentplan Mona 34-A



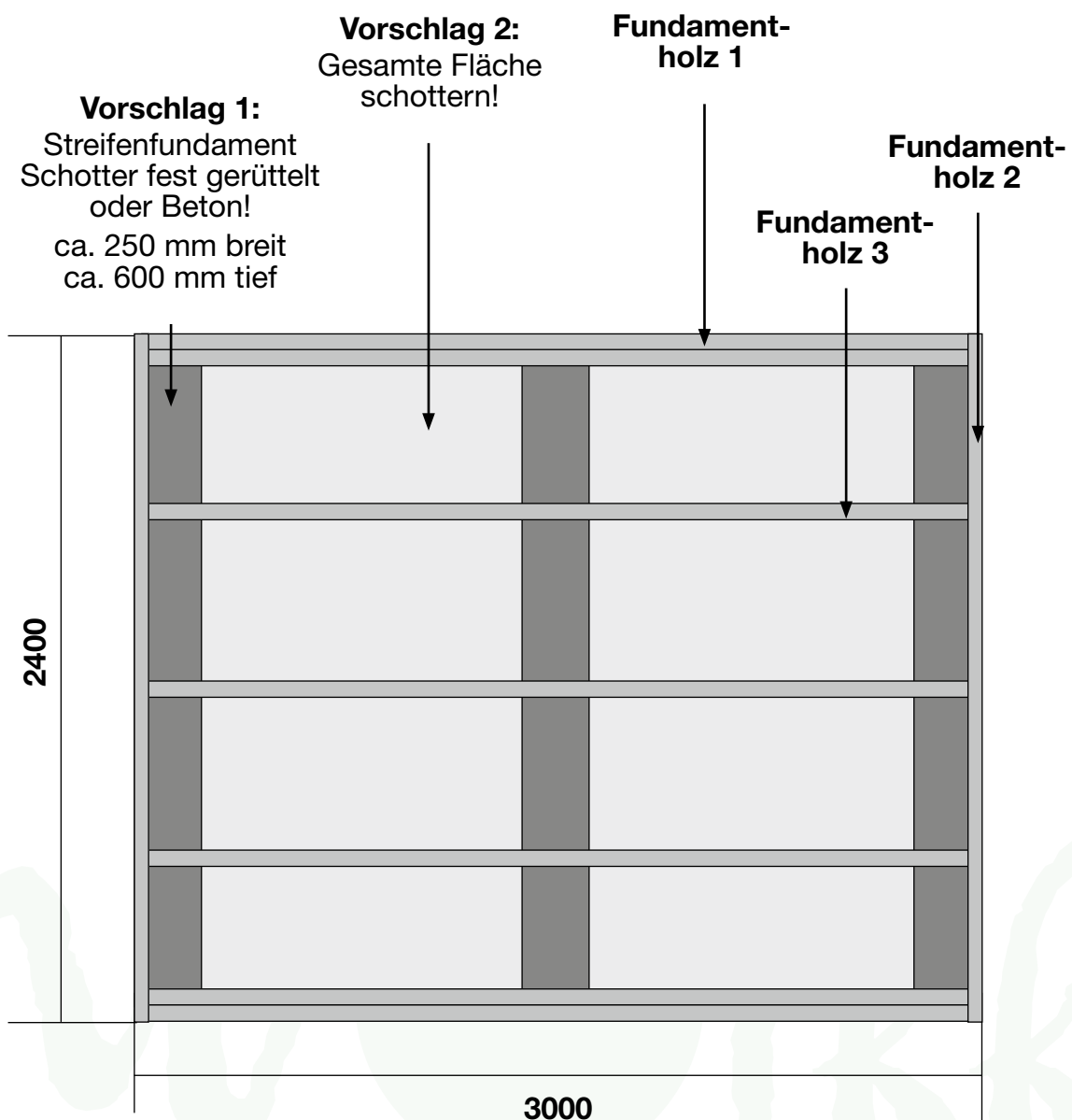

Haustyp	Anzahl der Fundamenthölzer (B x H x L)
Mona 34-A	Fundamentholz 1: 2 (45 x 70 x 2910 mm) Fundamentholz 2: 2 (45 x 70 x 2400 mm) Fundamentholz 3: 5 (45 x 70 x 2910 mm)



**Dieser Fundamentplan ist ein unverbindlicher Vorschlag und kann individuell verändert werden!**

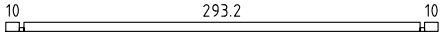
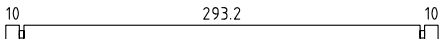
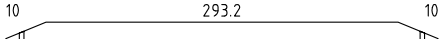
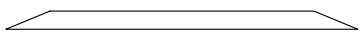
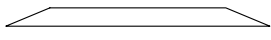

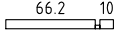
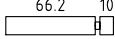
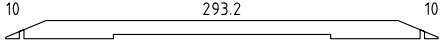
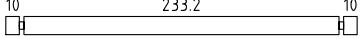
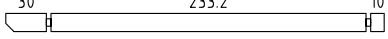
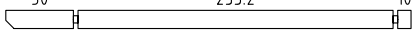
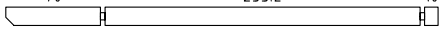
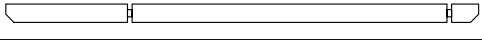
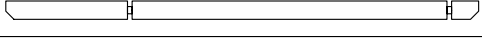
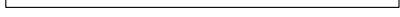

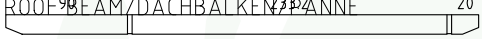
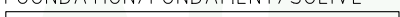





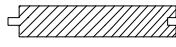
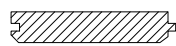

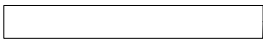

# Teileliste 1

## Mona 34-A

Pos		Stück	Profiil (cm)	Pikkus (cm)
001		1	3.4x6.8	320
002		14	3.4x13.5	320
003		1	3.4x13.5	320
004		2	3.4x13.5	260.6
005		2	3.4x13.5	195.5
006		2	3.4x13.5	130.3
007		2	3.4x13.5	65.2
008		2	3.4x6.8	79.6
009		28	3.4x13.5	79.6
010		1	3.4x13.5	320
011		22	3.4x13.5	260
012		2	3.4x13.5	280
013		2	3.4x13.5	300
014		2	3.4x13.5	320
015		1	3.4x13.5	350
016		1	3.4x13.5	350
AR2	FOUNDATION/FUNDAMENT/SOLIVE 	2	4.5x7	291
AR1	FOUNDATION/FUNDAMENT/SOLIVE 	2	4.5x7	240
PR1	ROOF BEAM/DACHBALKEN/PANNE 	2	4.3x14.5	350
PR2	ROOF BEAM/DACHBALKEN/PANNE 	1	4.3x14.5	350
PT1	FOUNDATION/FUNDAMENT/SOLIVE 	5	4.5x7	291
	DOOR 158.8x196.5	1		

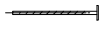
# Teileliste 2

## Mona 34-A

Pos	Zeichnung Mona 34-A	Stück	Profile (cm)	Länge (cm)
017	FLOOR BOARDS/FUSSBODEN/LAME DE PLANCHER 	26 22	11.2x1.8 13.7x1.8	232 232
018	ROOF BOARDS/DACHBRETTER/VOLIGE 	52 64	13.7x1.8 11.2x1.8	189.5 189.5
019	ROOF EDGE REINFORCEMENT/TRAUFENLEISTE/TASSEAU 	2	2.6x3.2	350
020	ROOF SIDE BOARDS/TRAUFENBRETT/PLANCHE DE RIVE 	2	1.8x9	350
021	FASCIA BOARD/GIEBELBLENDE/PLANCHE DE RIVE (FACADE) 	4	1.8x12.0	195
022	FASCIA BOARD/GIEBELBLENDE/PLANCHE DE RIVE (FACADE) 	4	1.8x6.0	195
023	STORM EDGE/STURMLEISTEN/STORM MOLDING 	4	2.6x3.2	200
024	FLOOR EDGE TRIM/FURBLEISTEN/PLINTHE PLANCHER 	4	2.0x4.5	293
025	DIAMOND/RAUTE/DIAMANT 	2	1.8x12	12
026	METAL BOLT/SCHRAUBE/BOLT 	8	M8	8
027	Shim, Nut/Mutter, U-Scheibe/Ecrou,Rondelle - M10 mm - For fixing storm braces/Pour fixer les anti-tempeste/Für Sturmleisten 	8	M8	
028	DOOR 142.5x196.5	1		
029	Nails/Nägel/Clous 2.5 x 50 mm - For fixing roofboards Befestigung Dachbretter/P our fixer les voliges 	520		
030	Nails/Nägel/Clous 2.0 40 mm - For fixing roofing felt fillet (18 x 90 mm)/ Befestigung Giebelabschluss Brett (18 x 90 mm)/ Pour fixer la latte de finition de la couverture (18 x 90 mm) 	20		
031	Screws/Schrauben/Vis 4 x 50 mm - For fixing roof side boards and roof edge reinforcement/Befestigung Traufenbrett und Traufenleisten Pour fixer les planches de rive et le tasseau (30 x 34 mm) de renfort 	54		
032	Nails/Nägel/Clous 2.5 x 25 mm - For fixing floorboards/ Befestigung Fußbodenbretter/Pour fixer les lames de plancher 	48		
033	Nails/Nägel/Clous 1.4 x 40 mm - For fixing floor edge trims (19 x 19 mm)/ Befestigung Fußleisten/Pour fixer les plinthes du plancher (19 x 19 mm) 	24		
034	Screws/Schrauben/Vis 4x70 mm - For bearers/ Befestigung Fundamentbalken/Pour fixer les solives 	28		

# Wandpläne A und B Mona 34-A

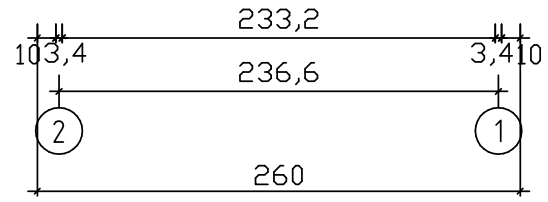
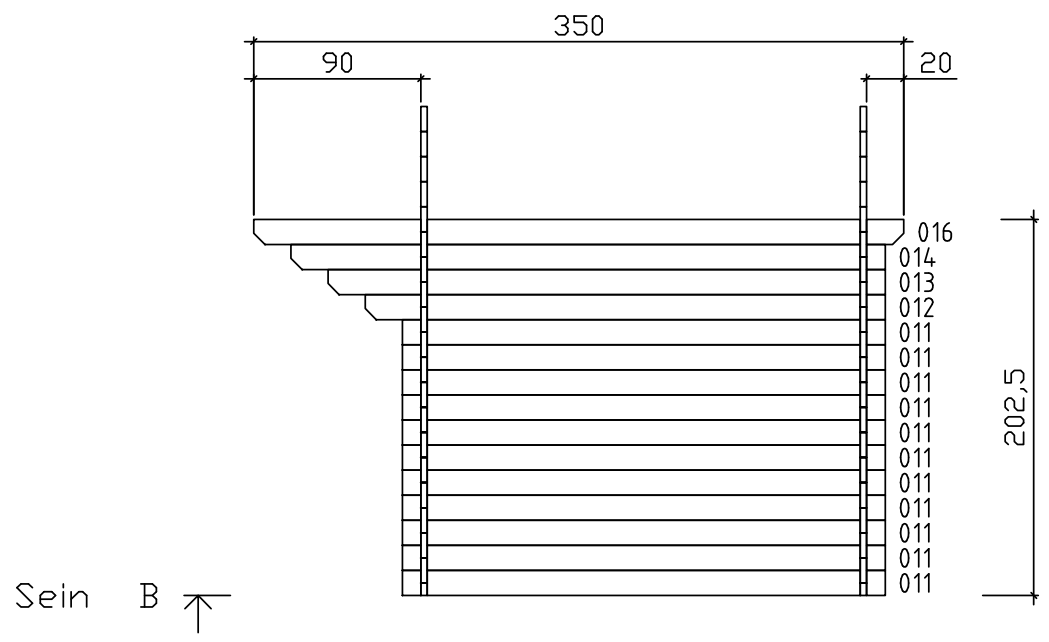
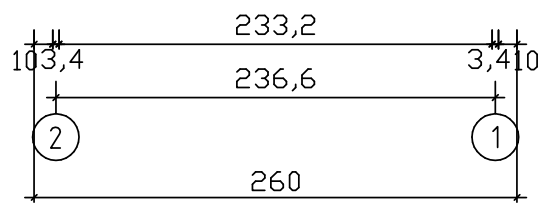
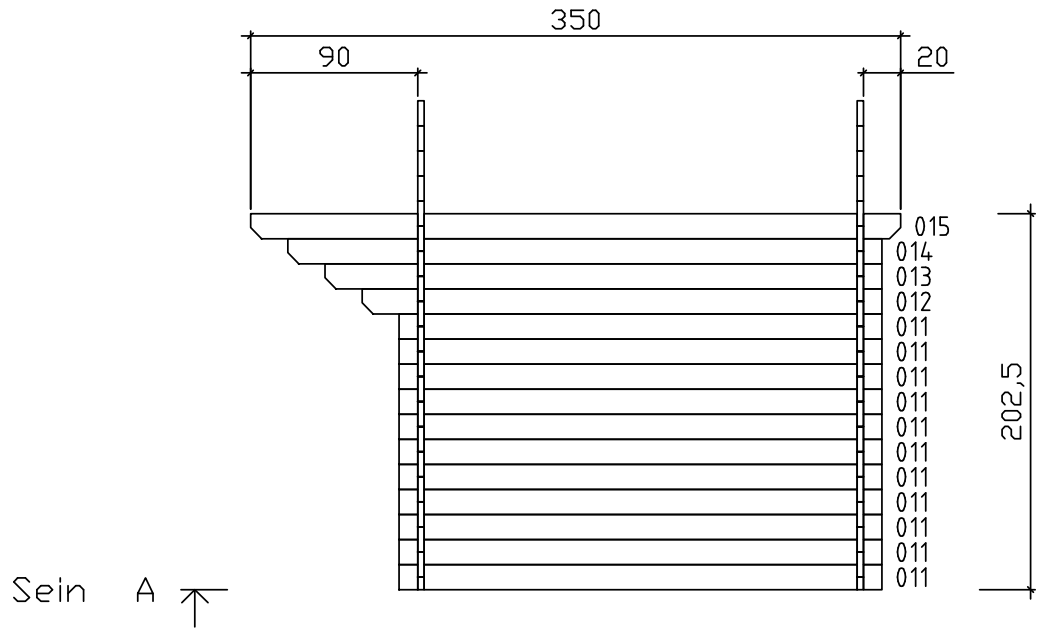

# Wandpläne 1 und 2 Mona 34-A

