

Technische Daten Monika 34-B

Wandaußenmaß: 300 x 300 cm
Bohlenstärke: 34 mm



Kontrolliert durch:

Achtung: Alle angegebenen Maße sind ca.-Maße!

3D-Darstellung Monika 34-B

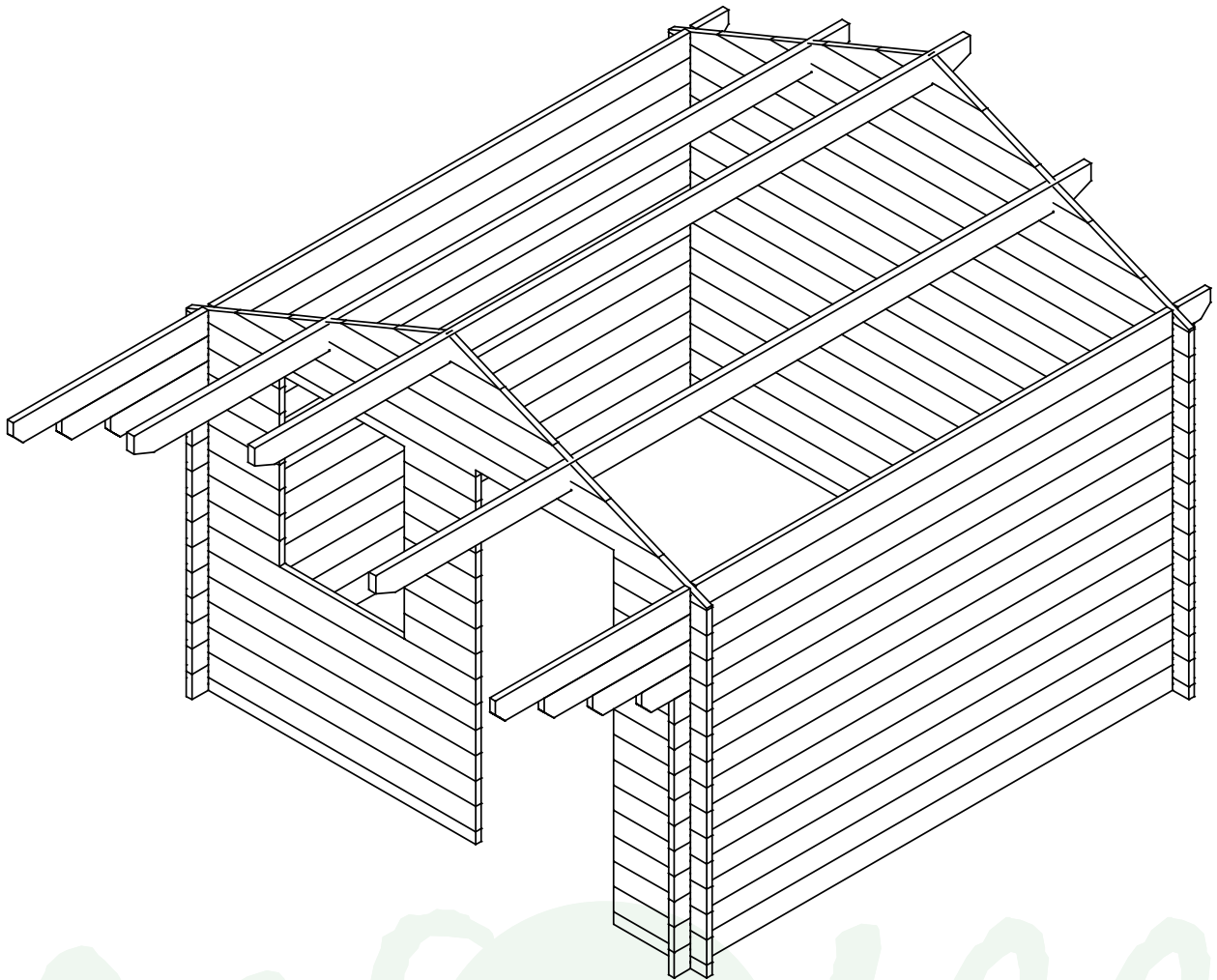

Grundriss und Lagerholzplan Monika 34-B

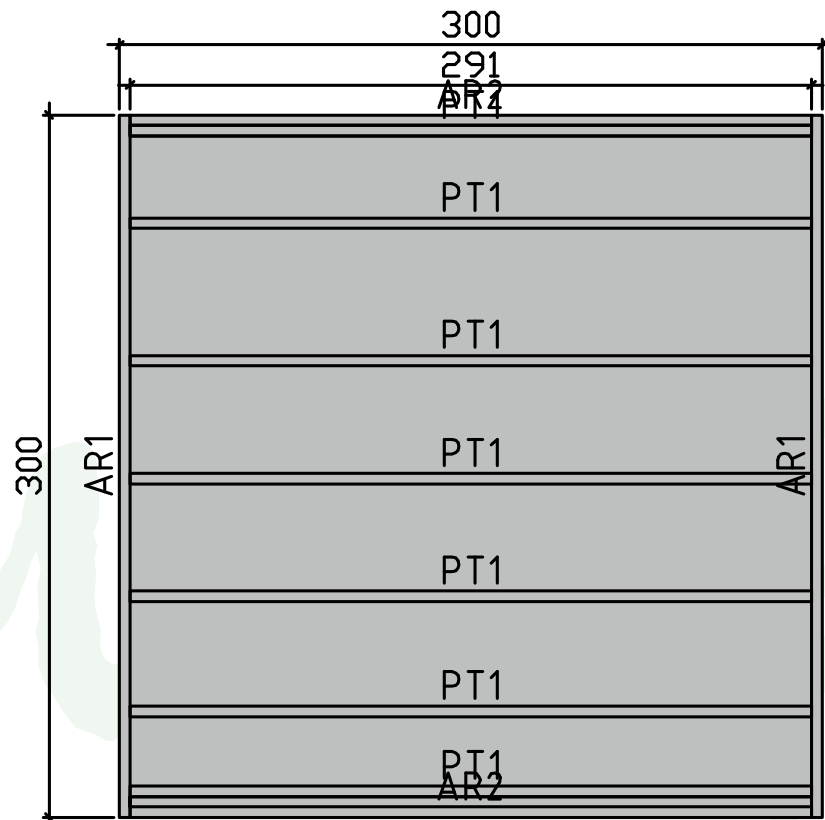
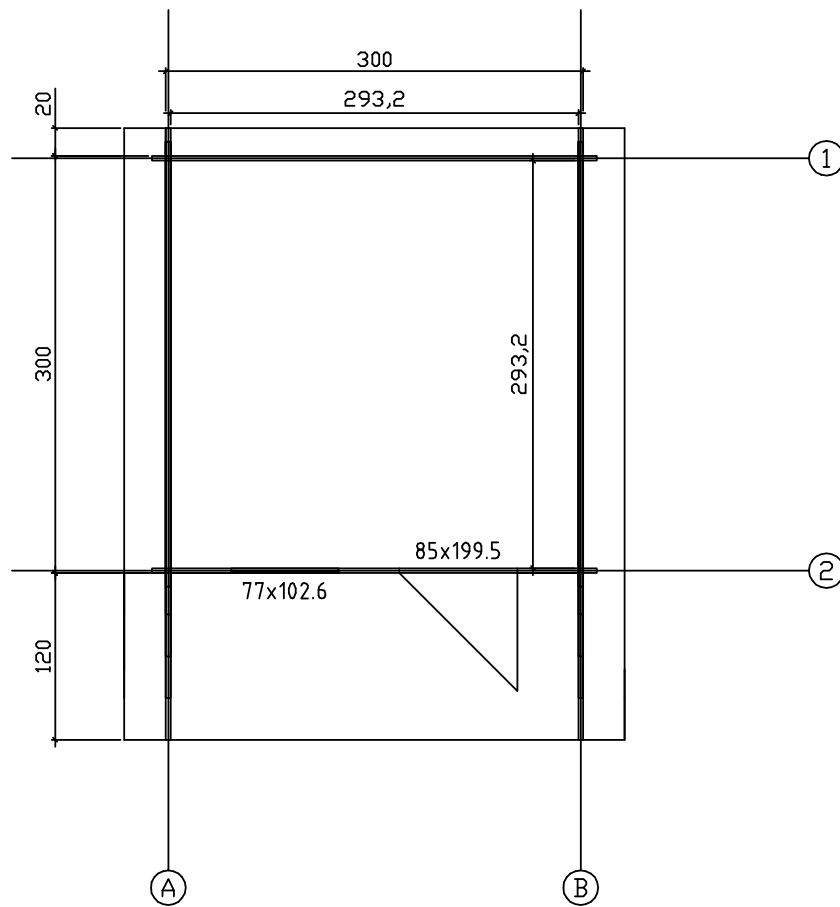

Fundamentplan Monika 34-B



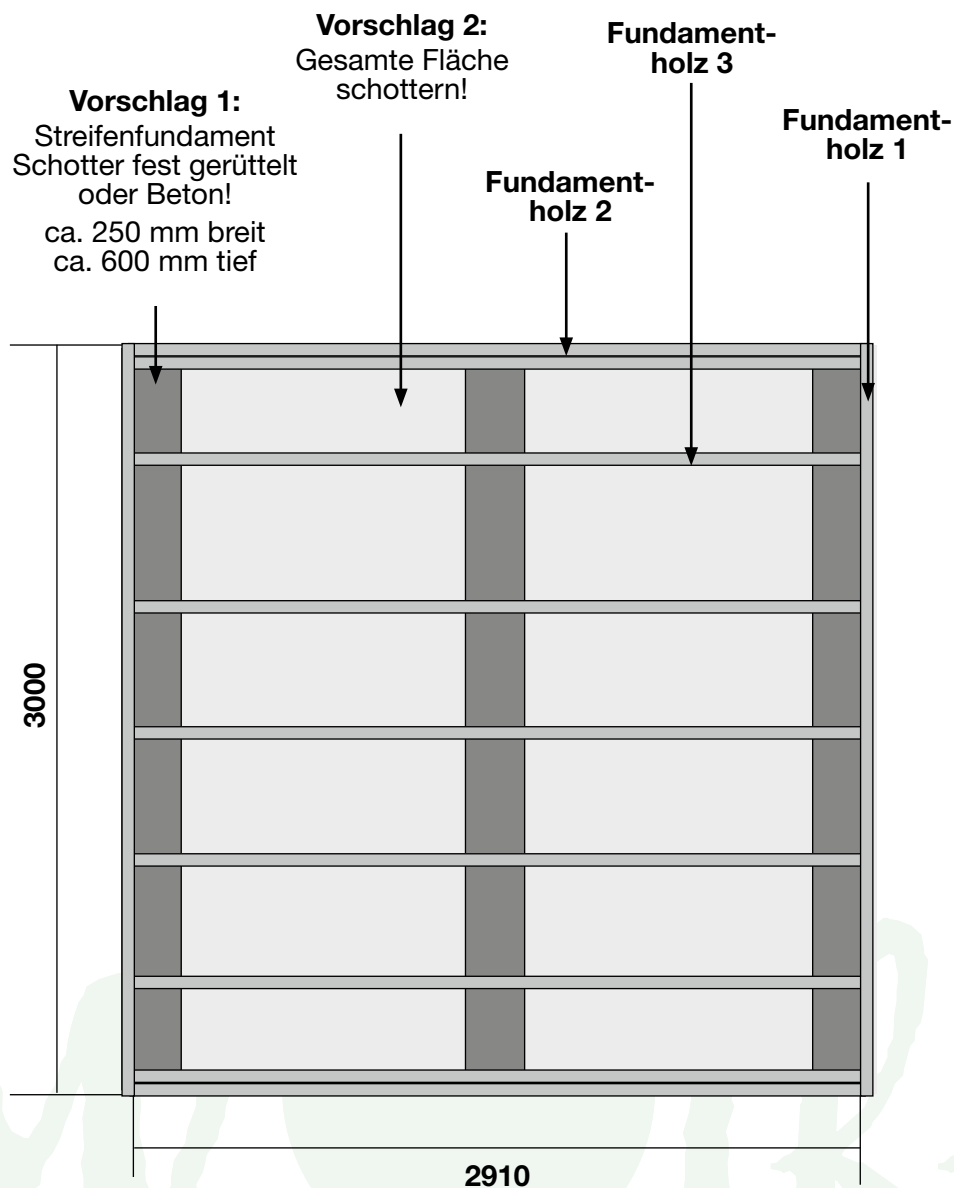







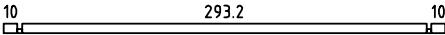
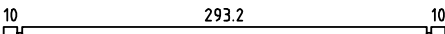
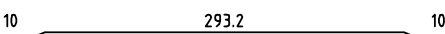
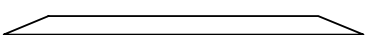
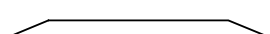
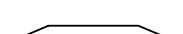

Haustyp	Anzahl der Fundamenthölzer (B x H x L)
Monika 34-B	Fundamentholz 1: 2 (45 x 70 x 3000 mm) Fundamentholz 2: 2 (45 x 70 x 2910 mm) Fundamentholz 2: 7 (45 x 70 x 2910 mm)

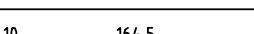

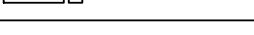
Dieser Fundamentplan ist ein unverbindlicher Vorschlag und kann individuell verändert werden!

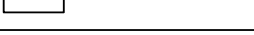
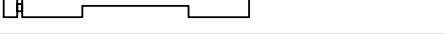
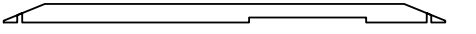
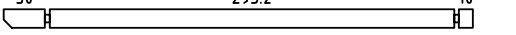
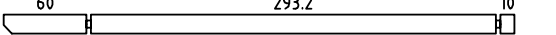
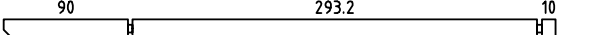

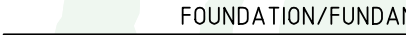
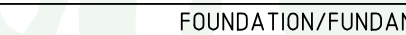







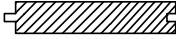

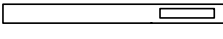
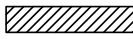
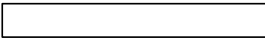
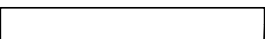
Teileliste 1

Monika 34-B

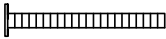
Pos		Stück	Profile (cm)	Länge (cm)
001		1	3.4x6.8	320
002		36	3.4x13.5	320
003		1	3.4x13.5	320
004		2	3.4x13.5	260.6
005		2	3.4x13.5	195.5
006		2	3.4x13.5	130.3
007		2	3.4x13.5	65.2
008		1	3.4x6.8	177.9
009		1	3.4x6.8	57.1
010		5	3.4x13.5	177.9
011		21	3.4x13.5	57.1
012		1	3.4x13.5	177.9
013		7	3.4x13.5	43.7
014		1	3.4x13.5	177.9
015		1	3.4x13.5	320
016		2	3.4x13.5	340
017		2	3.4x13.5	370
018		2	3.4x13.5	400
019		1	3.4x13.5	440
020		1	3.4x13.5	440
AR1	FOUNDATION/FUNDAMENT/SOLIVE 	2	4.5x7	300
AR2	FOUNDATION/FUNDAMENT/SOLIVE 	2	4.5x7	291
PT1	FOUNDATION/FUNDAMENT/SOLIVE 	7	4.5x7	291
PR1	ROOF BEAM/DACHBALKEN/PANNE 	2	4.3x14.5	440
PR2	ROOF BEAM/DACHBALKEN/PANNE 	1	4.3x14.5	440

Teileliste 2

Monika 34-B

Pos	Zeichnung Monika 34- B	Stück	Profile (cm)	Länge (cm)
	WINDOW 77x102.6	1		
	DOOR 85x199.5	1		
021	FLOOR BOARDS/FUSSBODEN/LAME DE PLANCHER 	26	11.2x1.8	292.0
022	ROOF BOARDS/DACHBRETTER/VOLIGE 	66 80	13.7x1.8 11.2x1.8	189.5 189.5
023	ROOF EDGE REINFORCEMENT / TRAUHENLEISTE / TASSEAU 	2	2.6x3.2	440.0
024	PULLER / STURMLEISTEN / GARNITURE SLAT 	4	2.6x3.2	200.0
025	ROOF SIDE BOARDS / TRAUHENBRETT / PLANCHE DE RIVE 	2	1.8x9	440.0
026	FASCIA BOARD / GIEBELBLENDE / PLANCHE DE RIVE (FACADE) 	4	1.8x12.0	195.0
027	FASCIA BOARD / GIEBELBLENDE / PLANCHE DE RIVE (FACADE) 	4	1.8x6.0	195.0
028	FLOOR EDGE TRIM / FUBLEISTEN / PLINTHE PLANCHER 	2	2.0x4.5	293.0
029	FLOOR EDGE TRIM / FUBLEISTEN / PLINTHE PLANCHER 	2	2.0x4.5	293.0
030	DIAMOND / RAUTE / DIAMANT 	2	1.8x12	120
031	BOLT / BOLZEN / BOULON 	8	M8	80
032	Shim, Nut / Mutter, M8 mm - For fixing storm braces / Pour fixer les anti-tempete / Für Sturmleisten 	8	M8	
033	Nails / Nägel / Clous 2.5 x 50 mm - For fixing roofboards Befestigung Dachbretter / Pour fixer les voliges 	520		
034	Nails / Nägel / Clous 2.0 x 40 mm - For fixing roofing felt fillet (18 x 90 mm) / Befestigung Giebelabschlusfbrett (18 x 90 mm) / Pour fixer la latte de finition de la couverture (18 x 90 mm) 	24		
035	Screws / Schrauben / Vis 4 x 50 mm - For fixing roof side boards and roof edge reinforcement / Befestigung Traufenbretter und Traufenleisten Pour fixer les planches de rive et le tasseau (30 x 34 mm) de renfort 	60		
036	Screws / Schrauben / Vis 2.5x25 mm - For fixing window and door trims / Befestigung Fenster und Türen / Pour fixer les croisillons des fenetres et des portes 	48		
037	Nails / Nägel / Clous 1.4 x 40 mm - For fixing floor edge trims (19 x 19 mm) / Befestigung Fußleisten / Pour fixer les plinthes du plancher (19 x 19 mm) 	24		

Wandpläne 2 Monika 34-B

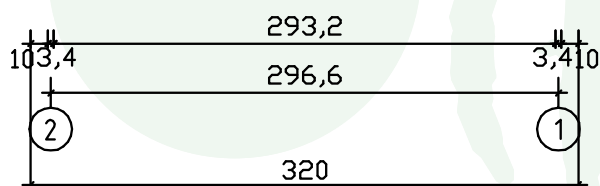
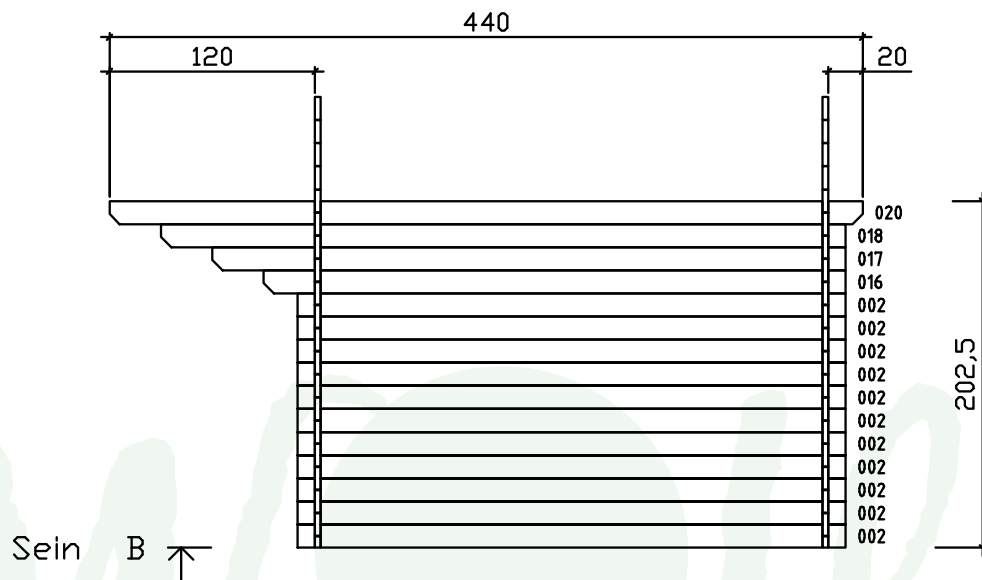
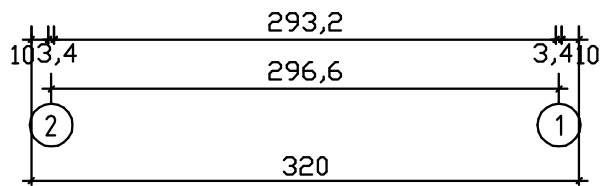
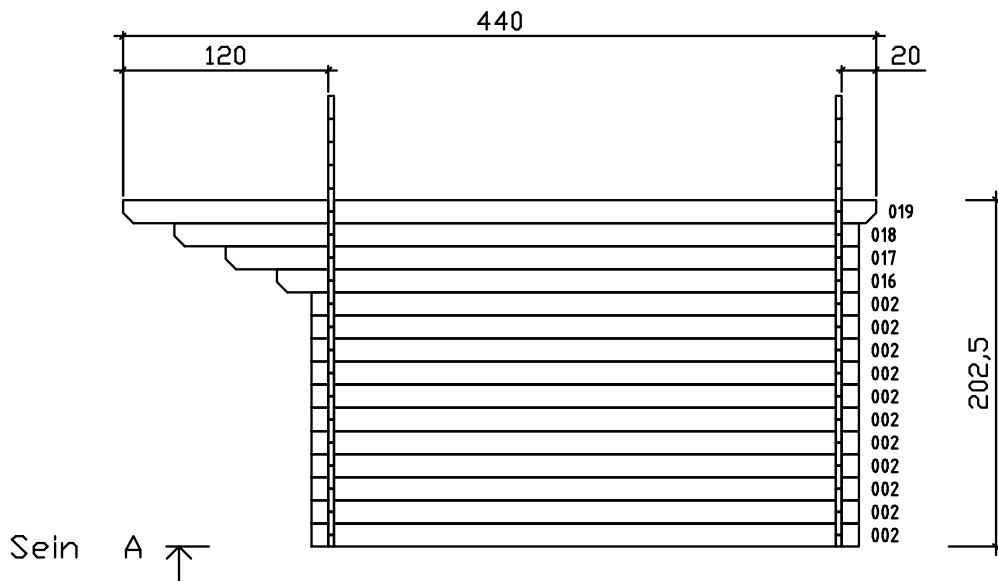

Detail Monika 34-B

