

Technische Daten Britta 34-A

Wandaußenmaß: 240 x 240 cm

Bohlenstärke: 34 mm



Kontrolliert durch:

Achtung: Alle angegebenen Maße sind ca.-Maße!

3D-Darstellung Britta 34-A

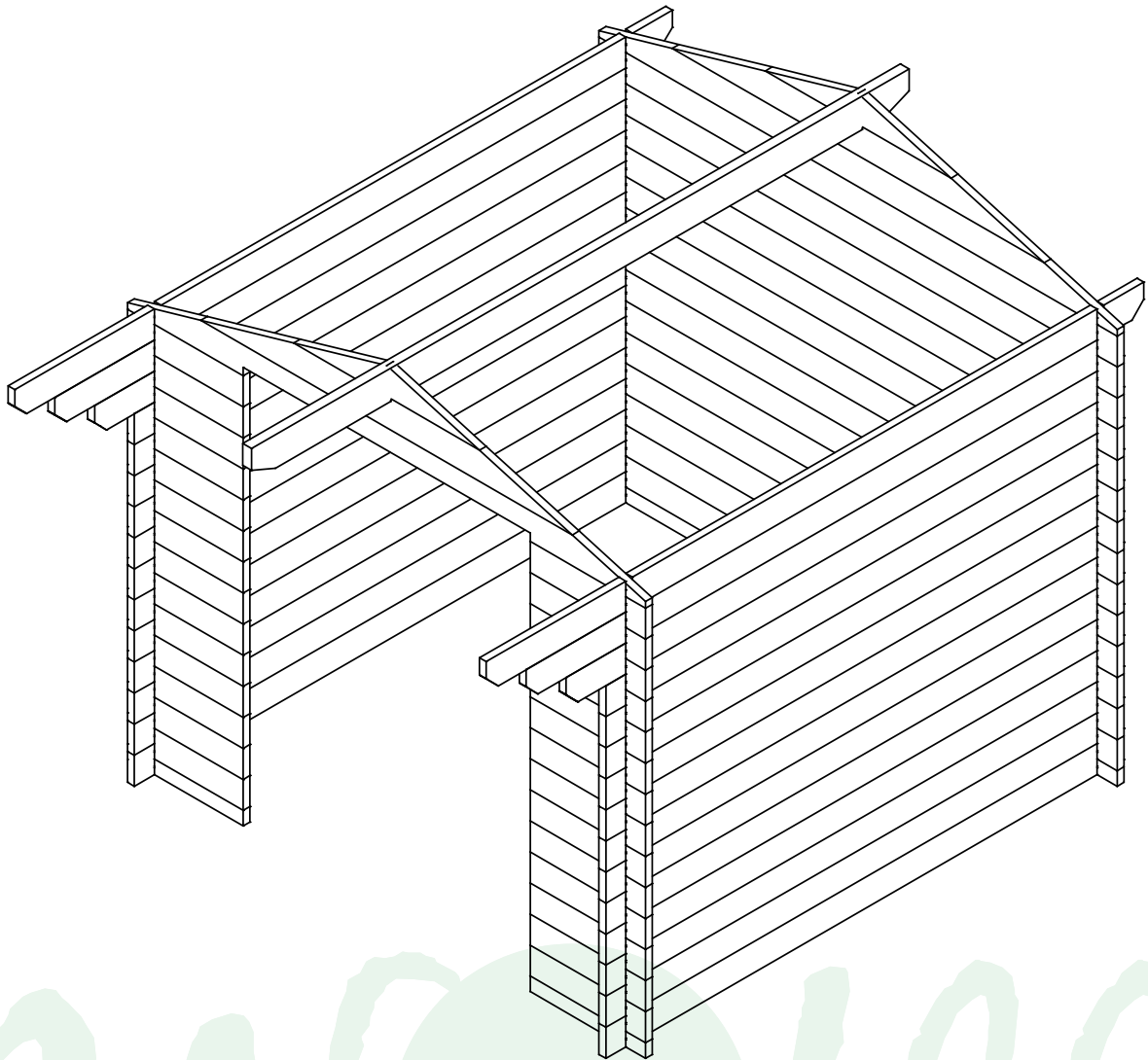

Grundriss und Lagerholzplan Britta 34-A

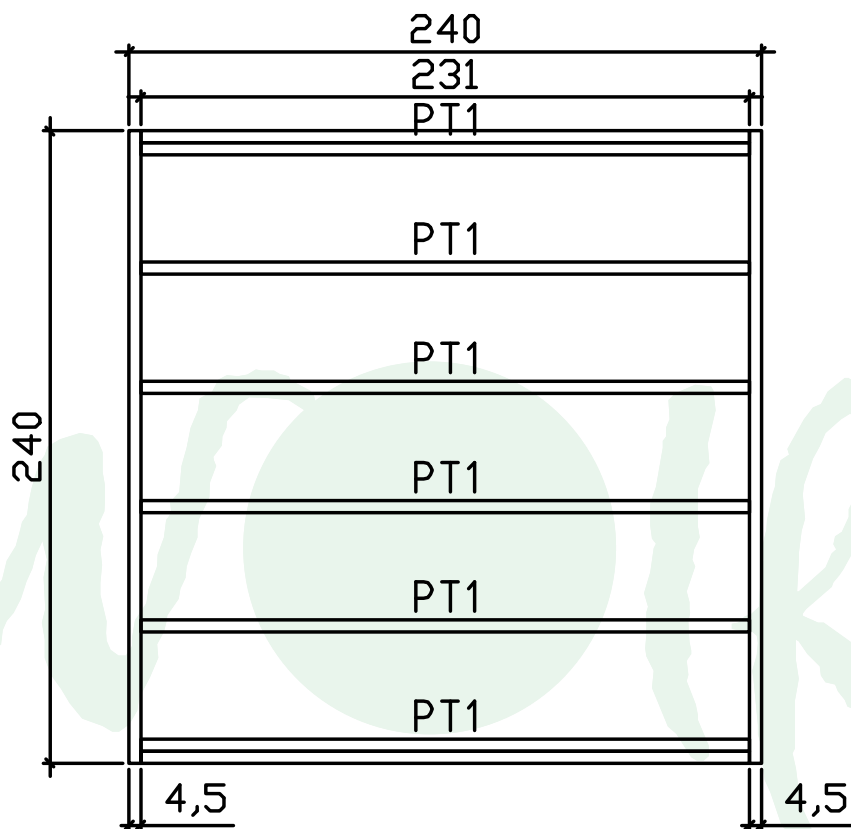
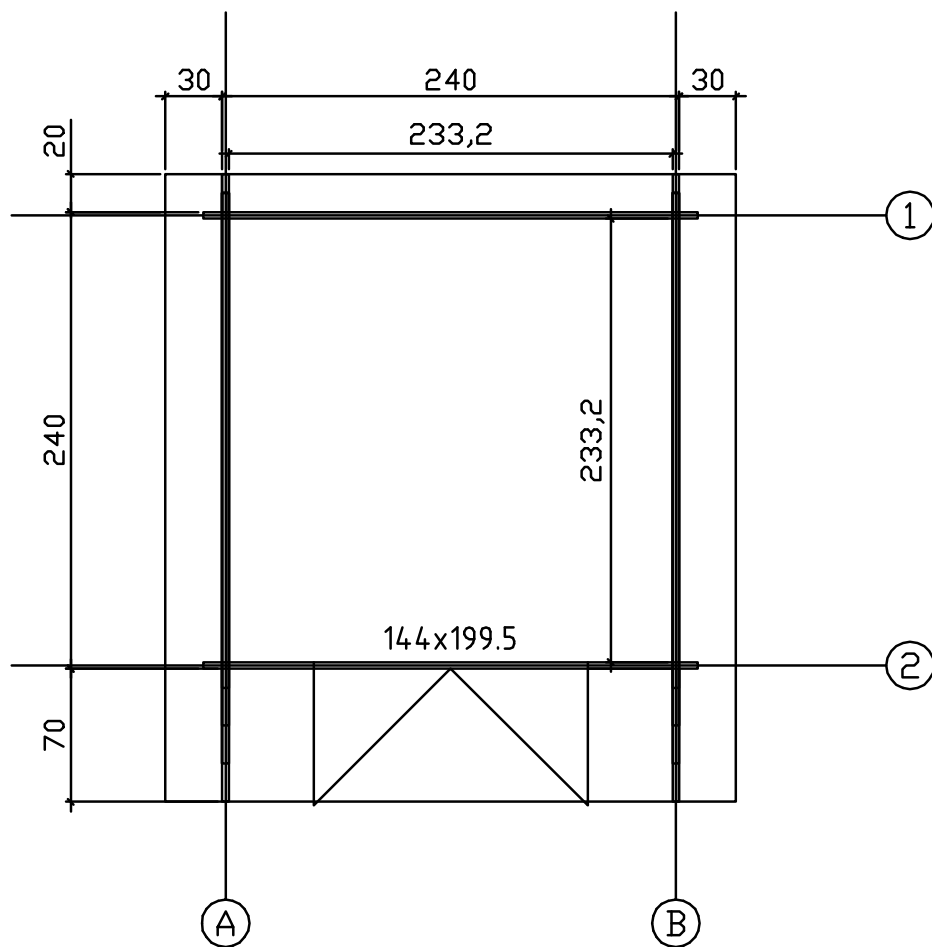

Fundamentplan Britta 34-A



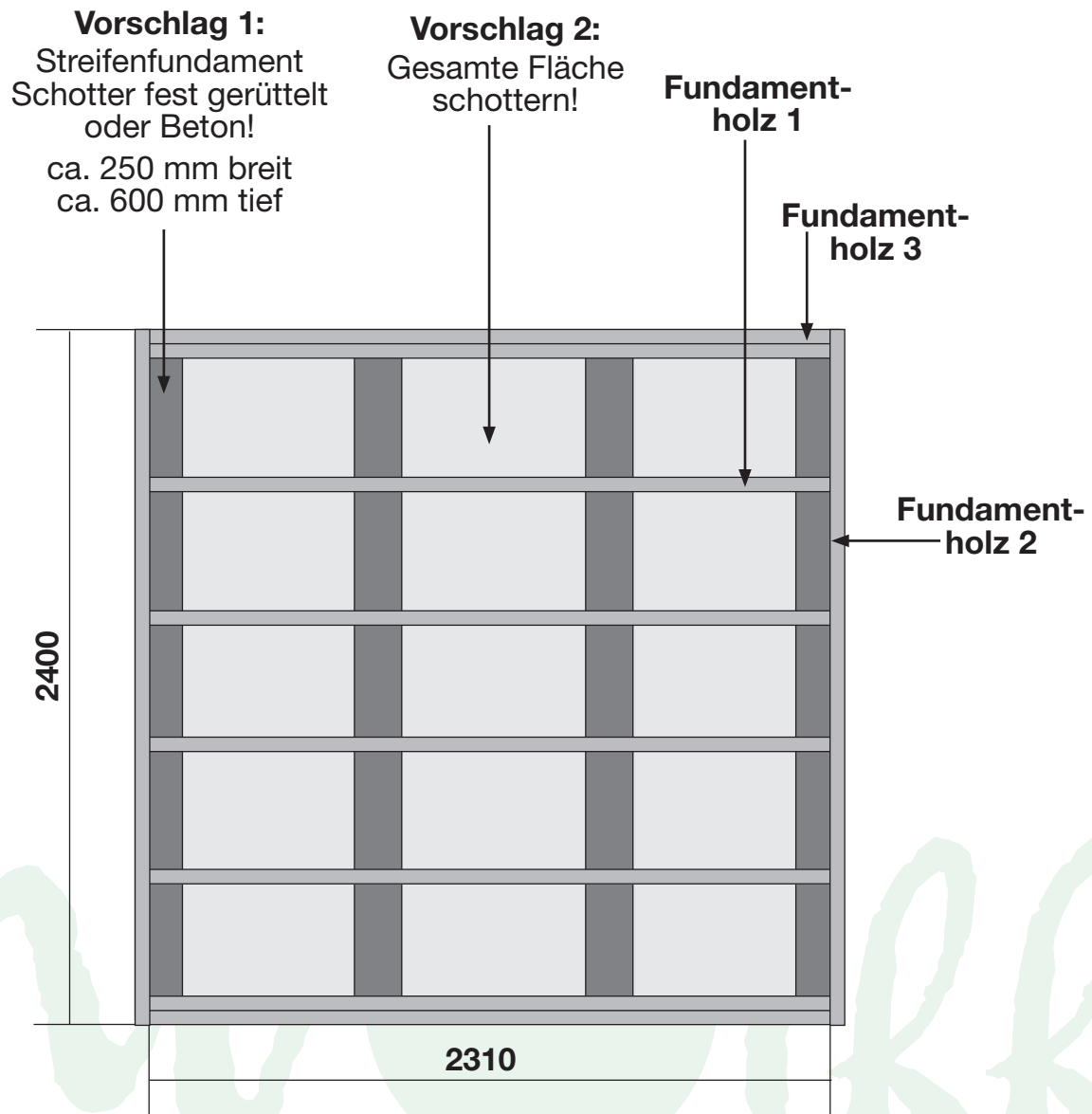







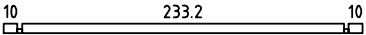
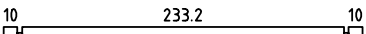
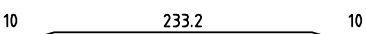
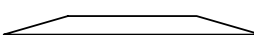
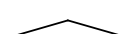

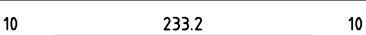
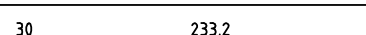
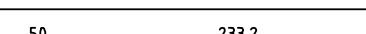
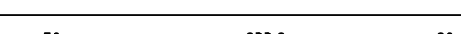
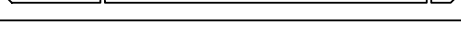
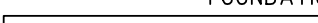
Haustyp	Anzahl der Fundamenthölzer (B x H x L)
Britta 34-A	Fundamentholz 1: 6 (45 x 70 x 2310 mm) Fundamentholz 2: 2 (45 x 70 x 2400 mm) Fundamentholz 3: 2 (45 x 70 x 2310 mm)

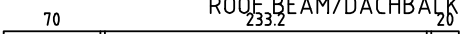
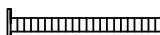

Dieser Fundamentplan ist ein unverbindlicher Vorschlag und kann individuell verändert werden!

Teileliste 1

Britta 34-A

Pos		Stück	Profile (cm)	Länge (cm)
001		1	3.4x6.8	260
002		38	3.4x13.5	260
003		1	3.4x13.5	260
004		2	3.4x13.5	186.6
005		2	3.4x13.5	93.3
006		2	3.4x6.8	58
007		28	3.4x13.5	58
008		1	3.4x13.5	260
009		2	3.4x13.5	280
010		2	3.4x13.5	300
011		1	3.4x13.5	330
012		1	3.4x13.5	330
PT1	FOUNDATION/FUNDAMENT/SOLIVE 	6	4.5x7	231
AR1	FOUNDATION/FUNDAMENT/SOLIVE 	2	4.5x7	240
AR2	FOUNDATION/FUNDAMENT/SOLIVE 	2	4.5x7	231
PR1	ROOF BEAM/DACHBALKEN/PANNE 	1	4.3x14.5	330
	DOOR 144x199.5	1		
013	BOLT/BOLZEN/BOULON 	8	M8	80
014	Shim, Nut/Mutter, M8 mm - For fixing storm braces/Pour fixer les anti-tempete/Für Sturmleisten 	8	M8	
015	Nails/Nägel/Clous 2.5 x 50 mm - For fixing roofboards Befestigung Dachbretter/P our fixer les voliges 	500		
016	Nails/Nägel/Clous 2.0 40 mm - For fixing roofing felt fillet (18 x 90 mm)/ Befestigung Giebelabschlu ßbrett (18 x 90 mm)/ Pour fixer la latte de finition de la couverture (18 x 90 mm) 	24		
017	Screws/Schrauben/Vis 4 x 50 mm - For fixing roof side boards and roof edge reinforcement/Befestigung Traufenbretter und Traufenleisten Pour fixer les planches de rive et le tasseau (30 x 34 mm) de renfort 	60		
018	Screws/Schrauben/Vis 2.5X25 mm - For fixing window and door trims/ Befestigung Fenster und Türen/P our fixer les croisillons des fenetres et des portes 	30		
019	Nails/Nägel/Clous 1.4 x 40 mm - For fixing floor edge trims (19 x 19 mm)/ Befestigung Fu ßleisten/Pour fixer les plinthes du plancher (19 x 19 mm) 	20		
020	FLOOR BOARDS/FUSSBODEN/LAME DE PLANCHER 	21	11.2x1.8	232.0

Wandpläne 2 Britta 34-A

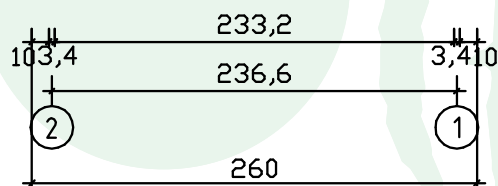
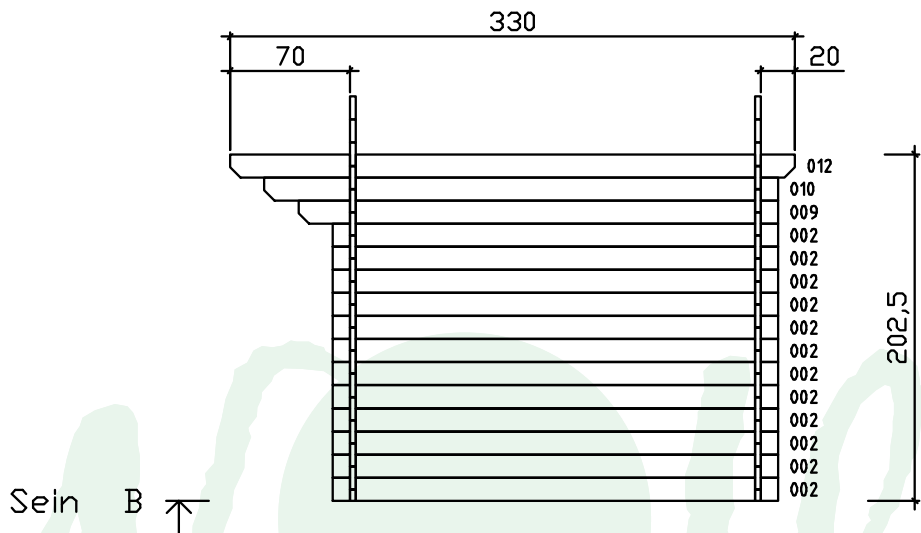
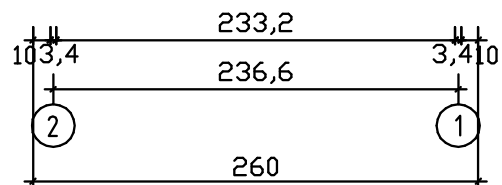
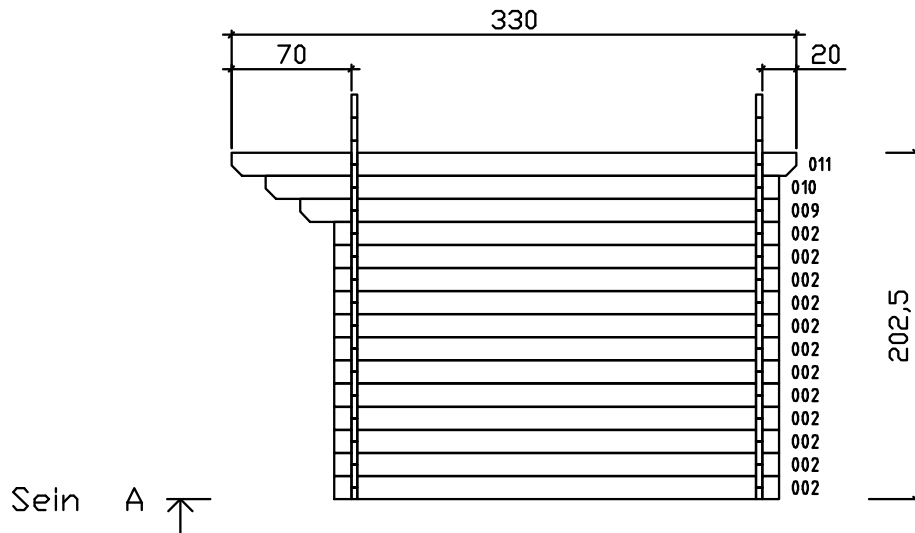

Detail Britta 34-A

